

go-e



Installation and operating manual go-e Controller

valid for article number: CH-30-01

V 1.2

TABLE OF CONTENTS

1	Important symbols Page 4
2	Charge smarter Page 4
3	Note before installation and commissioning Page 5
4	Safety regulations/notes Page 6
5	Product overview Page 8
6	Scope of delivery Page 9
7	Technical data Page 10
8	Installation Page 12
9	Installation (additional sensors) Page 16
10a	Commissioning/operation on the device Page 18
10b	Commissioning/operation via app Page 33
11	PV Surplus Charging/Load Balancing Page 42
12	Warranty and exclusion Page 47
13	CE Declaration of Conformity Page 47
14	Contact and support Page 49

1. Important symbols



Warning of a dangerous situation which may result in damage to health, fatal injury or damage to property if the safety regulations are not followed.



Note on adapting the product or product functions to individual needs.

Tip for more ecological or economical product use.



The activity may only be carried out by a qualified electrician.

2. Charge smarter

Thank you for your purchase decision

With the go-e Controller you manage the energy flows of buildings. As a result, depending on the position of the sun and the current power demand in a building, charging processes of electric cars can be controlled even more smartly in interaction with go-e Chargers. You can also use the device simply to monitor consumers in the building.

The go-e Controller helps you as a so-called energy management system (EMS) in an electrical distribution system to collect measured values and make them available to other devices in a network. This means in particular, that photovoltaic surplus charging and dynamic load balancing can be implemented with go-e Chargers without any further programming knowledge.

Keep an eye on the power flows in your building and maximize automatically the self-consumption of your PV system when charging with go-e Chargers. For the go-e Charger of the Gemini and Gemini 2.0 series, PRO series and Home series (V3) even with automatic phase switching.

Control the charging process of electric cars with dynamic load balancing to avoid overloading your power connection. If required due to many power consumers running at the same time, the charging power of the go-e Chargers connected to the Controller is automatically adjusted.

The go-e Controller is compatible with all PV inverters* and AC electricity battery storage solutions. Furthermore, compatibility with all go-e Chargers and the go-e app is also given.

The Controller provides a graphical representation of power consumption in real time. Measured values acquired by the Controller are collected directly via the current transformers supplied and the voltage supply established by the electrician. A 1-phase or 3-phase operation of the Controller is possible.

*PV optimisation is also possible without direct measurement of production by the inverter. Own production can be measured and visualised via a sensor for AC inverters only.

3. Note before installation and commissioning



Observe all safety regulations and instructions in this manual!

Download the data sheet: www.go-e.com



Summarized:

The Controller manages an unlimited number of Chargers so that they charge electric cars when sufficient power is available. Depending on your preference, with and without power from the grid.

The go-e Controller can be controlled directly via a display. The go-e app makes it even more convenient to use.

The Controller can be integrated into a network via WiFi or Ethernet. The go-e Controller has no shortage of other interfaces for connecting to existing solutions: In addition to HTTP API, MQTT and Modbus, a cloud API is also available to integrate the go-e Controller.



Much of the information in this manual is intended for the installer, who must perform the installation and should perform the basic configuration. The settings for optimized charging processes and the connection of additional charging stations to the Controller can be conveniently implemented by the user in just a few steps via the go-e app.



Tip: PV surplus charging can even be combined with flexible electricity prices. This enables even more sustainable and cost-effective charging.

We wish you much joy with your go-e Controller.

Your

go-e team



4. Safety regulations/notes

General safety regulations



The go-e Controller is to be used exclusively to collect measured values in an electrical system and to pass them on in a network in order to implement energy monitoring, to maximize the self-consumption of a PV system or to implement dynamic load management in interaction with go-e Chargers.

Failure to comply with the safety regulations can have serious consequences. go-e GmbH disclaims any liability for damage caused by disregarding the operating instructions, safety regulations or warnings on the device.

Mains voltage - danger to life! Never use the go-e Controller if the housing is damaged or open.

If unusual heat is generated, do not touch the go-e Controller and disconnect the power supply. In case of discoloration or distortion of the plastic, contact customer support.

Wearers of electronic implants should keep at least 60 cm away from the go-e Controller due to electromagnetic fields.

The go-e Controller has the communication interface WiFi 802.11b/g/n 2.4GHz. The WiFi is operated on a frequency of 2.4Ghz, channels 1-13 with the frequency band 2412-2472Mhz. The maximum transmit power of the WLAN is 20dBm EIRP.

Electrical protective measures, installation, operation



All information on electrical installation is intended exclusively for a qualified electrician whose training allows all electrical work to be carried out in accordance with the applicable national regulations.



The go-e Controller must be mounted by a qualified electrician in accordance with the complete operating instructions. The installation must be carried out in accordance with local, regional and national regulations.

An electric shock can be fatal. Disconnect the circuit from the power supply before making any electrical connections.

The Controller is mounted on a top-hat rail. Observe the permissible ambient conditions. At ambient temperatures of more than 45 °C, a safety distance of 10 mm to other devices in the control cabinet is recommended. An ambient temperature of 55 °C must not be exceeded.

The Controller should not be operated in the immediate vicinity of flammable or explosive substances, running water or heat-emitting equipment.

Make sure that the power connection leading to the go-e Controller is properly installed and undamaged.

An RCD type A, 30 mA must be provided on the building side, unless local regulations deviate from this. Independently of this, a line circuit breaker (recommendation: LS-3/B6) must be provided. Do not fuse the go-e Controller with more than 16 A.

The go-e Controller may only be operated on fully functional protective devices. Connection cables must be sufficiently dimensioned. We recommend a cable cross-section of at least 1.5 mm².

The current transformers should be attached in the direction of the current as described and illustrated in the installation instructions. This means that the arrows on the current transformers should point in the direction of the current consumer.

Always use the current transformers supplied. Alternative current transformers, which are also suitable for higher currents, may be used only after inquiry to go-e support and its confirmation in text form.

Opening, repair, maintenance



Any modification or repair to the hardware or software of the go-e Controller may only be carried out by qualified specialist of go-e GmbH.

Before dismantling an allegedly defective product, contact go-e's technical customer support in any case and wait for their decision on the further procedure for handling the service case.

Removing and damaging warning notices attached to the go-e Controller or opening the device will result in the loss of any liability by go-e GmbH. The manufacturer's guarantee also expires in the event of any modification or opening of a go-e Controller.

Do not cut the current transformer cables.

The go-e Controller is maintenance-free. The device can be cleaned with a damp cloth. Do not use any cleaning agents or solvents.

Disposal



According to guideline 2012/19/EU (WEEE Directive), electrical equipment must not be disposed of with household waste after the end of use. Take the device to a collection point specially set up for waste electrical equipment in accordance with national legal requirements. Also dispose of the product packaging properly in the waste paper collection so that it can be recycled.



Legal notice

The copyright to these operating instructions is held by go-e GmbH.

All texts and illustrations correspond to the technical status at the time of preparation of the manual. go-e GmbH reserves the right to make unannounced changes. The contents of the operating instructions do not justify any claims against the manufacturer. Pictures are for illustration purposes and may differ from the actual product.

5. Product overview

- a** Inlets for current measurement
Sensors 1-3
- b** Modbus RS485 x2
for later extensions
- c** Inlets for current measurement
Sensors 4-6
- d** 4 keys for menu navigation
- e** Brightness sensor
Display switches off automatically
- f** Color display (320 x 240 px)
- g** Power supply with
connecting clamp
- h** WiFi-antenna 2.4 GHz
- i** Ethernet 100 Mbit/s
- j** Type plate
with serial number of the Controller

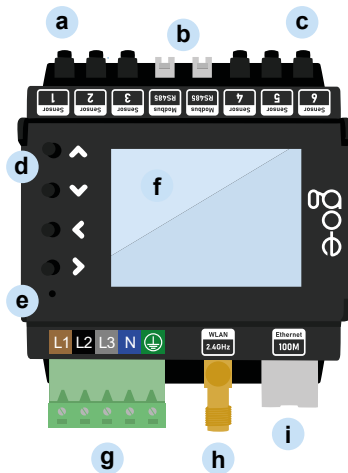

Back



6. Scope of delivery

- 1** go-e Controller
- 2** Connecting clamp
- 3** 6 Current transformers foldable, 100 A
with jack plug (90 degrees)
- 4** WiFi antenna, self-adhesive
optionally connectable
- 5** Ethernet flat cable 2 m
optionally connectable

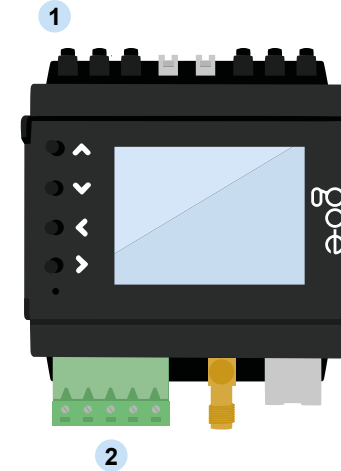

- 2** Connecting clamp

- 3** 6 Current transformers foldable, 100 A
with jack plug (90 degrees)

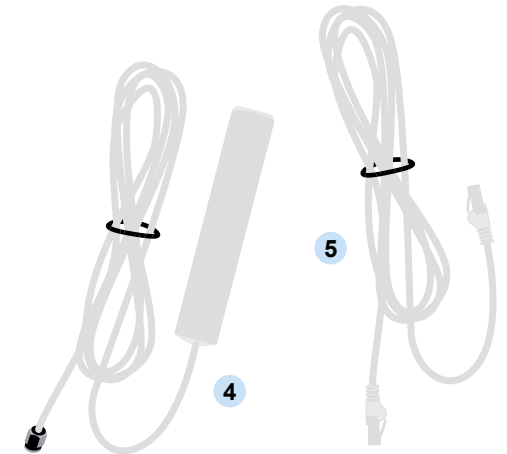
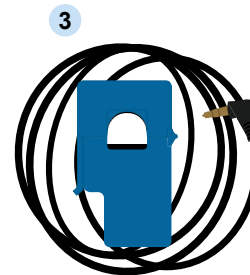

- 6** Data card



7. Technical data

Product specifications	
Dimensions (W x H x D)	approx. 72 x 90 (without plugs) x 61 mm (4 division units)
Weight	193 g
Voltage measurement	4 inputs three-phase (L1, L2, L3 and N) single-phase (L1 and N)
Nominal voltage	3 x 230 V (single-phase) / 400 V (three-phase)
Nominal frequency	50 Hz
Display	Color display
Compatibility	go-eCharger Home series go-e Charger Gemini series go-e Charger Gemini 2.0 series go-e Charger PRO series All PV inverters* All AC battery storage systems**

*PV optimisation is also possible without direct measurement of production by the inverter. Own production can be measured and visualised via a sensor for AC inverters only.

**A DC-coupled battery storage system cannot be measured, but you can prevent it from being permanently discharged when charging the electric vehicle by adjusting the settings in the app (not for HOME series V2).

Measurement functions: nominal voltage			
	Min	Nominal	Max
L1 - PE L2 - PE L3 - PE		230 V	277 V
L1 - N	100 V	230 V	277 V
L1 - L2 L1 - L3 L2 - L3		400 V	
Inputs for current measurement			
	Sinus	RMS	Peak
max. measurable current	100 A		144 A
max. permanent current (thermally limited)		140 A	

Network	
Ethernet 802.3	10M / 100M, Full-Duplex or Half-Duplex DHCP or static IP address
WiFi station 802.11 b/g/n 2,4GHz	Supported encodings: open / WEP / WPA / WPA2 / WPA3 up to 10 configurations can be saved DHCP or static IP address
WiFi Access Point	for local connection with the app or API Channel freely adjustable from 1 - 13 SSID and password adjustable deactivatable

Interfaces and features		
	Possible in the local network	Cloud connection
Modbus TCP API	yes	not possible
MQTT API	yes, connections in local networks and to the internet possible	not possible
HTTP API	yes	yes
Connection to go-e Chargers (HOME series V3 / Gemini series / Gemini 2.0 series / PRO series)	yes, number not limited	Optional data transmission via cloud possible (necessary if not in the same subnet or separated by NAT)
Connection to go-e Chargers (HOME series V2)	no	Cloud connection at go-e Charger HOME V2 and go-e Controller has to be established
Dynamic load balancing	yes, local transmission of measured values	Cloud connection on the go-e Charger must exist
go-e app	yes, automatically finds go-e Charger in local network with mDNS	yes, remote access with serial number and password input
Log data recording and export with measured values	not via the go-e app / go-e cloud / display. Own data acquisition via API possible	yes
Graphical representation of the power consumption in the past	not via the go-e app / go-e cloud / display. Own data acquisition via API possible	yes

8. Installation scheme



Have the go-e Controller installed and configured by a qualified electrician in accordance with local installation standards.



An electrical installation distributor is recommended as the place of installation. If there is no more space, it is also possible to install the go-e Controller in a new surface-mounted / flush-mounted distributor next to it and to lay the connection cables for voltage measurement and current transformers there.



After completing the installation, please note that the firmware of the go-e Charger and go-e Controller should always be up to date to ensure that they function as intended at all times. The firmware of both products can be updated, for example, via the go-e app in the menu item "Internet".

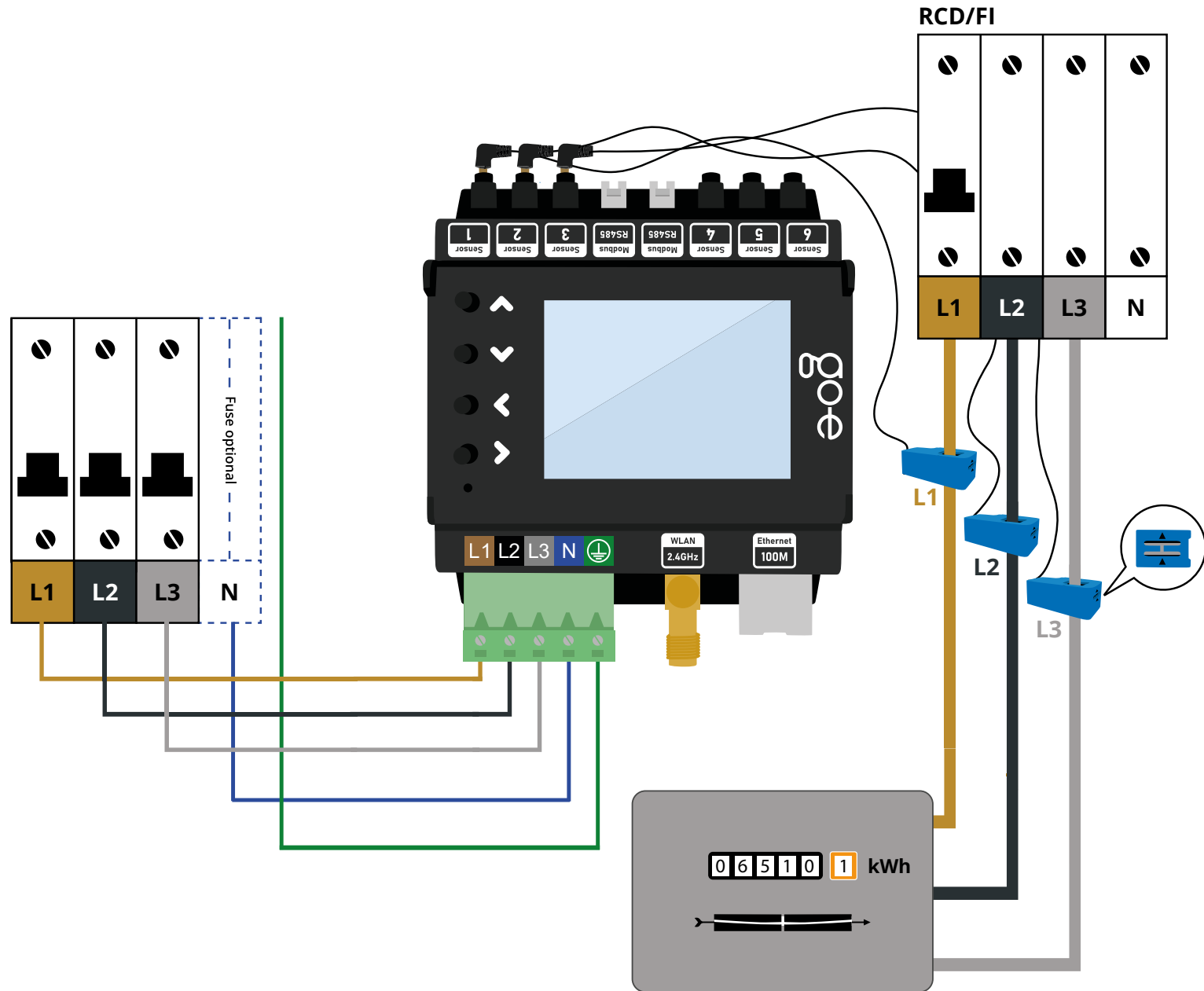

8. Installation

a

Required tools

- a Screwdriver

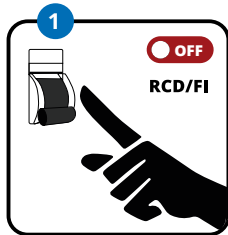

1. Ensure that the circuit is de-energised by observing the five electrical safety rules.

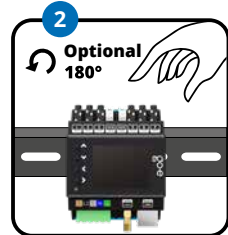

2. Mount the go-e Controller on the DIN rail. We recommend mounting according to the illustration. However, the Controller can also be mounted rotated by 180°.



Please note: The display can be rotated accordingly under the menu item "settings/device/rotate display".

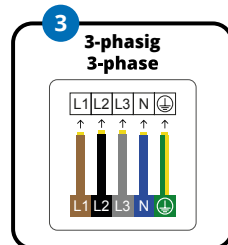
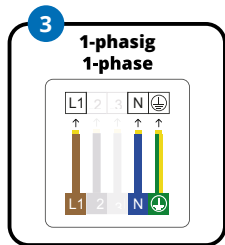

3. Connect the Controller single-phase or three-phase depending on the power connection. If necessary, lay additional supply line. Insert the conductors into the connecting clamp and fix it with a screwdriver. Also connect the neutral conductor and the protective earth.

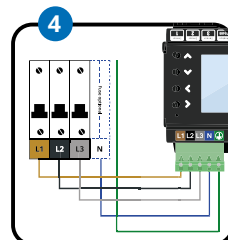
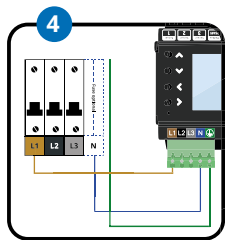

4. The go-e Controller can also be connected to a fuse of another consumer, for example the electric oven. If this is not possible, you need to install a new fuse.

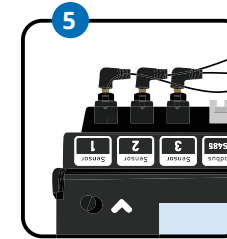

5. For PV surplus optimisation, we need enough sensors to measure the power from or to the grid. For three-phase connection, plug the jack plugs of three current transformers into the designated inputs for current measurement. For example, in sensors one to three. For single-phase connection, use only one current transformer. The easiest way to do this is to measure directly at the mains connection.

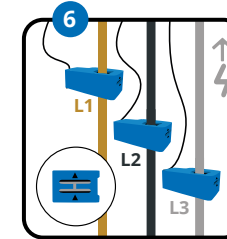
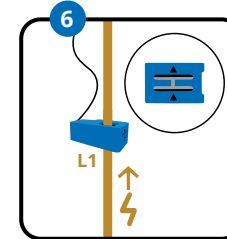

6. Attach one current transformer per phase. The two arrows on the current transformer must point in the direction of the current. When connecting to the power grid, which we call the "grid", the arrow should point from the power grid towards the house.*

Please note: A maximum of one current transformer may be attached to one phase.

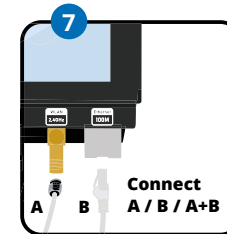

7. Now connect the WiFi antenna and/or the Ethernet cable to the Controller.



For optimal reception, lead the flat cable of the WiFi antenna out of the installation distributor to attach the top there.

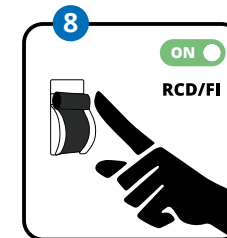

8. You do not want to connect any further sensors? (This is not necessary for the PV surplus optimisation.) Then restore the voltage supply. Next, follow the instructions from point 5 in chapter 9 Installation (additional sensors).



*If it is not possible to install the current sensors with the arrow pointing in the specified direction for space reasons, the sensors can also be inverted via the Controller menu or the app.

9. Installation (additional sensors)



After completing the basic installation, you can use the remaining 3 to 5 current transformers, depending on the type of connection (single-phase or three-phase), to measure the current flows of various devices or groups of consumers in the building. This is suitable, for example, for an AC PV inverter, an AC battery storage system or large electrical consumers such as boiler, air conditioning or heat pump.

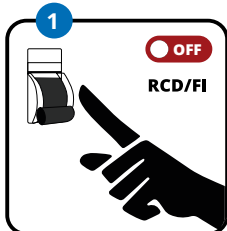

1. Ensure that the circuit is de-energised by observing the five electrical safety rules.

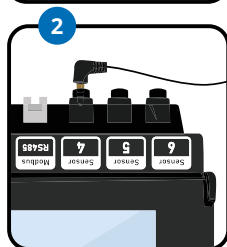

2.

Plug the jack plug of a current transformer into one of the inputs for current measurement that are still free and marked "Sensor". You can assign them as you wish. Clip the current transformer onto one phase of the device or circuit whose current flows you want to measure. With 3-phase devices that supply the same power on all phases, measuring only one phase is usually sufficient. This is the case, for example, with an AC inverter.

Again, please note that a current transformer may only be attached over one phase, otherwise no measured values can be recorded.

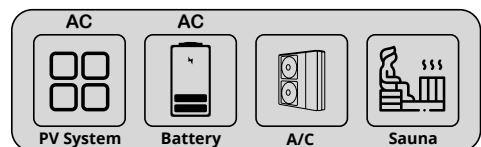

You want to measure and visualise your own PV production?

If you want to measure and visualise your PV production, you must always measure the current using a sensor on one phase of your AC-PV inverter. For a solar inverter, the arrow on the current transformer should point from the inverter to the distribution board.



You have a battery storage system that should be taken into account for the optimisation of the power consumption?

Then use a current transformer to measure one phase of the **AC battery storage**. For an AC battery, the arrow on the current transformer should point from the battery to the distributor. A **DC-coupled battery storage system** cannot be measured, but you can prevent it from being permanently discharged when charging the electric vehicle by adjusting the settings in the app (not for HOME series V2).

PV optimisation is also possible without direct measurement of production by the inverter.

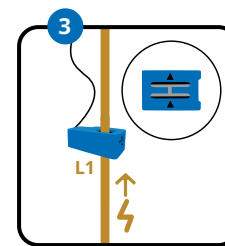

3.

The connection of a current transformer is also sufficient for measuring the current of other 3-phase major consumers. You can also use the current transformers to measure the consumption of individual circuits, such as lighting, a boiler, air conditioner, sauna or heat pump. **When measuring these loads, the arrow on the current transformer should point in the direction of the load.**

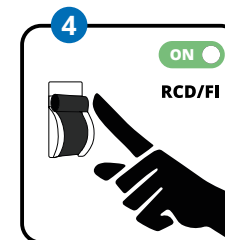

4.



You have installed all current transformers or do not want to use all sensors? Have you completed the electrical connection work? Then reconnect the power supply to the circuit.

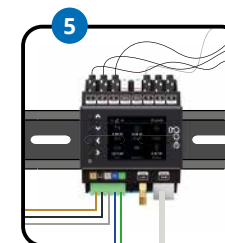

5.

The Controller now switches on and is ready for operation after the system has booted up. Most likely, the display will still show wrong measured values, we still have to assign the correct phase and category to the sensors. Now you have to carry out the initial configuration. You can choose between these two methods.

a) Commissioning/operation via the buttons and the display on the unit

b) Configuration via the app

If you have already installed go-e Chargers, they will be automatically recognised by the Controller after the configuration has been completed. To do this, the Controller has to be in the same network as the Chargers. The Controller can be connected to an unlimited number of Chargers.

When using WiFi repeaters, remember that they extend your home network and do not create a new network with a different IP address. This works best with repeaters from the same brand of your access point or WiFi router.

10a. Commissioning/operation on the device

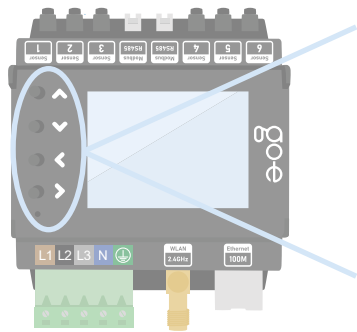

- ▲ Use the 4 buttons on the device to move through the menu on the display.
- ▼ If you are in a submenu in which a keyboard is displayed, e.g. to assign a password, you can also press and hold a button to navigate more quickly to the desired letter, for example.
- ◀
- ▶

1. Start screen

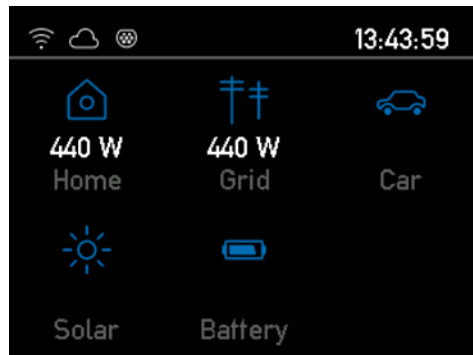

As soon as the go-e Controller is ready for operation, you can already see the first measured values on the home screen, which are probably still incorrect. The sensor configuration is described later.

You can access the main menu by pressing the > button without selecting a category. To go back, press the < key.

2. Main menu / Settings

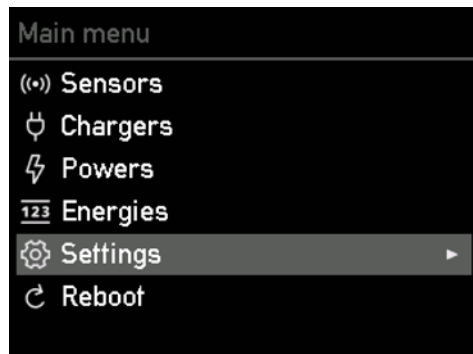

Use the up and down keys on the unit to switch between the individual menu items.

Press the > key to select the menu item "Settings".

3. Settings / Device

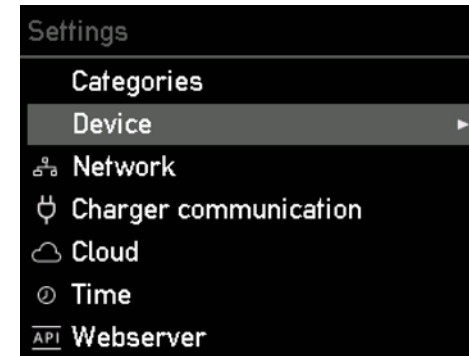

Press the > button to select the menu item "Device". Here you can, for example, adjust the language or the display of the go-e Controller to your wishes.

4. Device

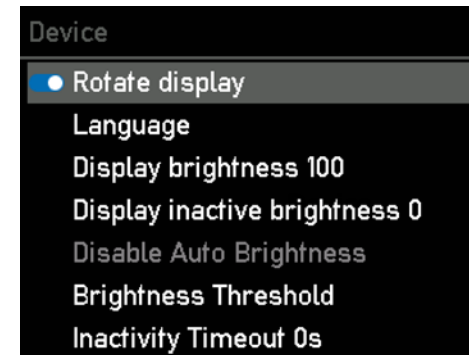

In the submenu "Device" you can e.g.:

1. rotate the display by 180° if you have mounted the Controller upside down for space reasons
2. select your preferred language
3. adjust the brightness of the display
4. modify the brightness of the display when inactive
5. define after which period of inactivity the display should switch off completely

5. Main menu / Sensors

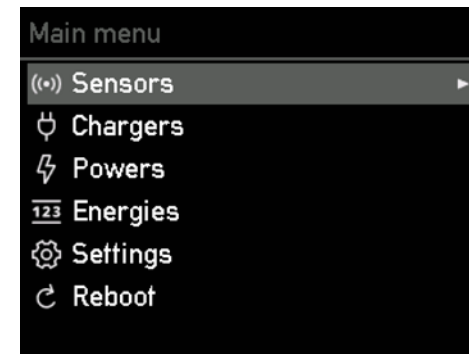

Press the > key to select the menu item "Sensors". In the menu item "Sensors" you can carry out the configuration.

10a. Commissioning/operation on the device

6. Sensors

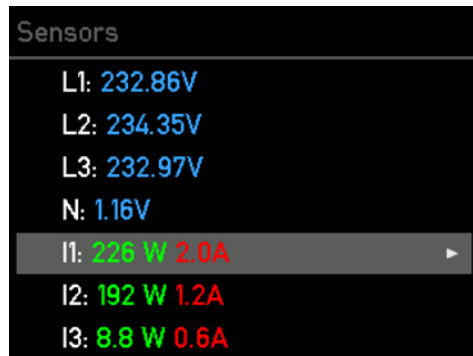

Under "Sensors" you can read the voltages, currents and power in real time. L1 to L3 show the voltage of the phases connected to the connecting clamp. I1 to I6 show the values of the connected sensors (current transformers). I corresponds here to the designation Internal, which corresponds to the connected sensor or also means load.

If you select L1, L2, L3 or N, you get to the voltage settings of the phase.

7. Sensors / Voltage settings

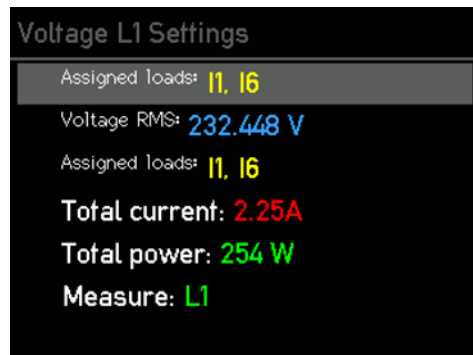

Here you can see all the measured values of the selected phase as well as the assigned loads (internal/arom sensors). Just check whether the voltage is approximately correct. If the current and total power are not yet correct, this is not a problem, because this configuration will be explained a little later.

Press the < button to return to the "Sensors" overview.

8. Sensors / Load settings

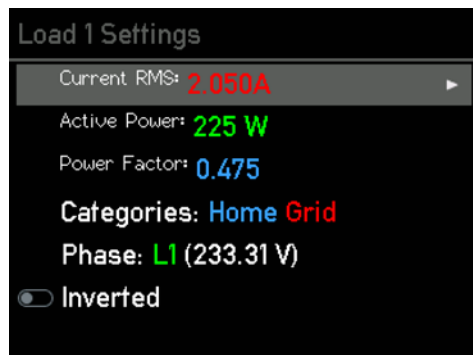

If you select one of the loads (I1 to I6) on the "Sensors" page, you will get to the "Load settings" overview.

Here you can use the slider to invert a load if you have not connected a current transformer with the arrows in the direction of the current.

In order for the power calculation to be correct, the phase must be set correctly. Imagine that the sensor measures 2 amps on your mains

connection, but without a voltage reference we do not know whether we are feeding power into the mains or drawing power from it.

Note that the power should always be positive when drawing from the grid. **With a solar inverter or an AC battery, the power should be positive in feed-in operation**, but if the battery is charged or the inverter has more standby consumption than generation, the power may be negative. If no power is being consumed, the power should be close to zero.

It is very important that the correct phase is set as the voltage reference. To find out which phase you have connected the sensor to, trace the cables in the switch cabinet. Alternatively, you can use a multimeter to check whether the voltage at the go-e Controller matches the fuse of the load.

The power factor can be between minus one and plus one. Minus one means maximum feed-in or charging for a battery without reactive power, plus one means maximum draw or production of energy. If the power is particularly low, the power factor is not very meaningful.

For a pure ohmic load, the power factor should be close to one.

To check the voltage allocation, you can simply switch on a large consumer with heating elements in your household, e.g. a fan heater, a hairdryer or the electric cooker. If your electric cooker is connected to a three-phase system, checking is especially easy because all phases are directly loaded with a power factor of almost one. If the power factors are incorrect and, for example, only plus or minus

one third or two thirds, you must adjust the assignment. As long as the allocation is not correct, your Controller cannot distinguish between feed-in and mains supply and the PV surplus regulation will not work.

This submenu can also be used to define the load categories by navigating to "Categories" and confirming with >.

9. Sensors / Load settings / Load categories

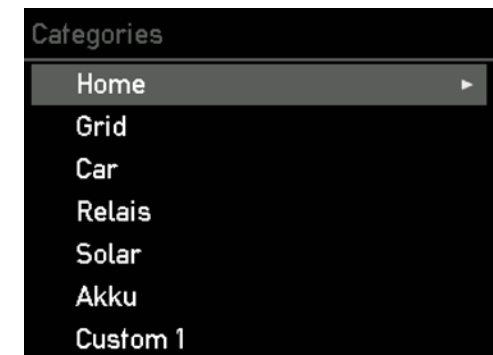

After you have selected the "Categories" line in the "Load settings" menu with the > key, you will reach this submenu.

The go-e Controller does not know which sensor you have mounted where. You set this with the respective category.

There is the category Grid. This category is the most important, because go-e Charger and go-e Controller try to regulate it as much as possible to zero during PV surplus charging.

10a. Commissioning/operation on the device

Below we explain 3 examples of how to configure the categories.

Example 1:

If you have mounted the respective sensor directly on one phase of the grid connection, you should set the Grid category to one. If you do not measure your household consumption separately, you should also set the Home category to one. This will allocate the entire current of the measured line directly to mains supply and household consumption.

If you have mounted a sensor on the line of a PV inverter, you can assign the power directly to the solar category. The power should be positive when the inverter is producing solar power. If you measure all phases in a single-phase or three-phase inverter, choose a factor of 1.

However, if you have a three-phase inverter and

only measure one phase, you can select the factor 3, the Controller then assumes 3 times the measured power, since we only measure one third.

We now have to assign the solar power to the home category. Let's take a look at this calculation example:

- Grid: we draw 1 kW from the grid
- Solar: Solar: we generate 500 W of solar energy

We have already allocated the 1 kW of grid consumption to Home. However, since we produce another 500 W ourselves, the total power we consume in the house is 1.5 kW. Therefore, please also assign the solar inverter to the Home category with the factor 1 or 3, depending on the number of measured phases of the inverter.

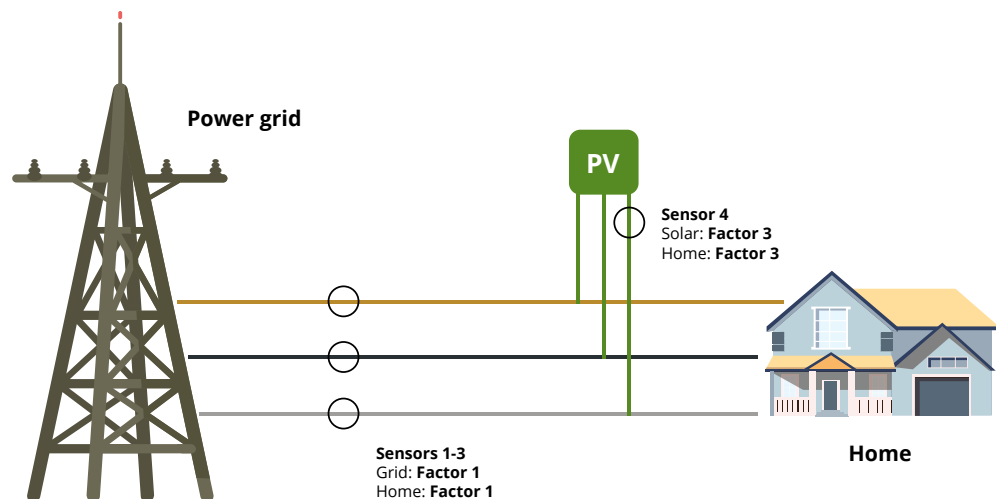

Example 2:

Let's assume we measure the load branch and the inverter on all phases. Then the categories correspond to the following picture:

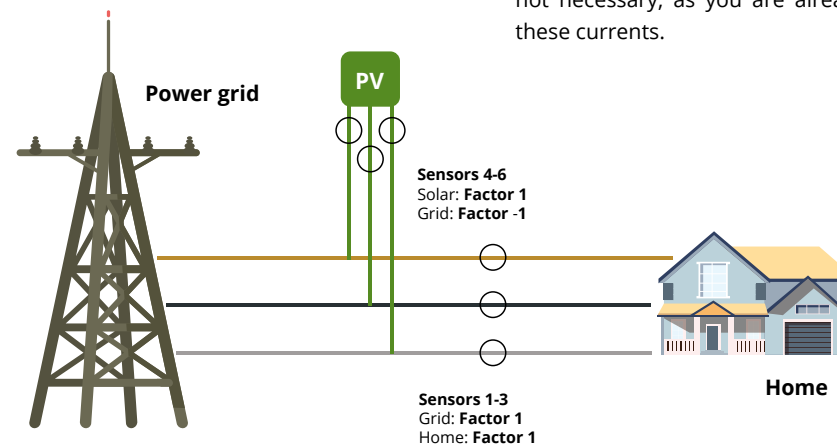

We have to subtract the solar production from the grid, so we have to set the factor to minus one.

If you simply measure a load, for example a boiler, you can assign it to a custom category, for example "Custom 1". You can rename the category later. Assigning it to Grid or Home is not necessary, as you are already measuring these currents.

Example 3:

If your solar inverter is connected to other loads too far away from the control cabinet with the go-e Controller, you cannot measure it directly. As already mentioned, this does not matter for PV surplus charging.

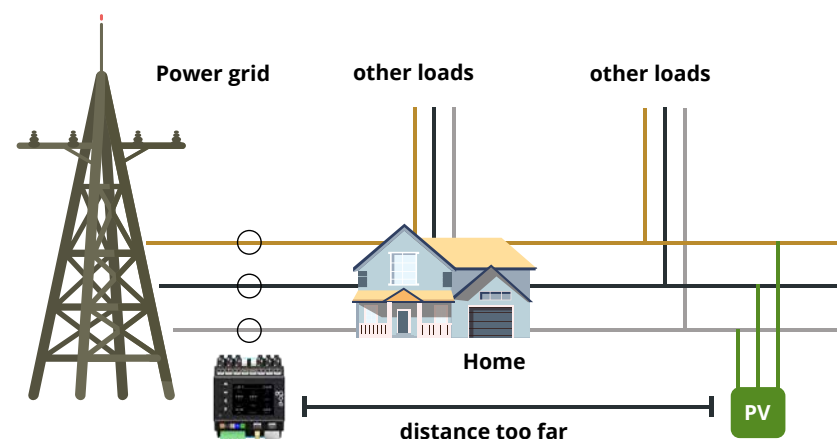

10a. Commissioning/operation on the device

10. Sensors / Load settings / Load category / Factor settings

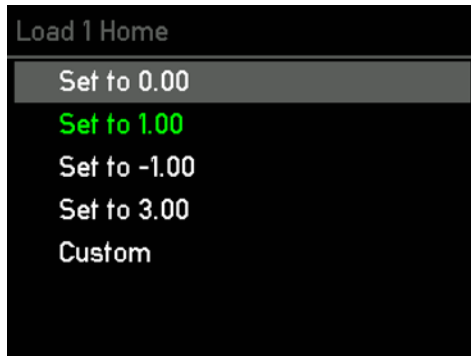

After you have identified the correct categories, you can set them in the menu.

Determine in the submenu with which factor your sensor value is to be taken into account on which category.

For a three-phase mains connection, repeat the assignment made for Internal 1 for the sensors Internal 2 and 3.

11. Sensors

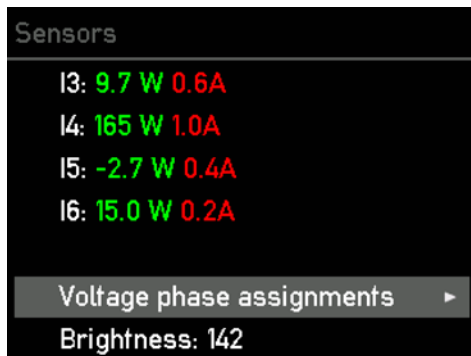

This step and the following steps are optional in case you have connected one or more phases of the power supply incorrectly.

Then you can change the voltage phase assignments by going back to "Sensors" in the menu, navigating to the bottom and selecting the option with the > key.

12. Sensors / Voltage phase assignments

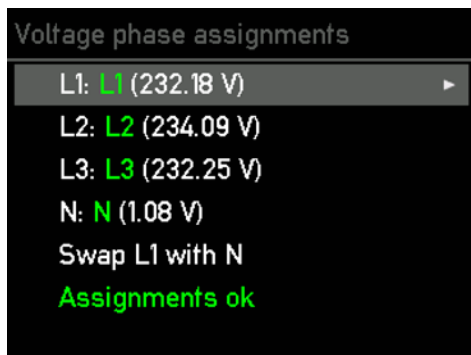

Optional step: Select the phase for which you want to change the assignment with the > key.

13. Sensors / Voltage phase assignments / Source phase



Optional step: Select the phase for which you want to change the assignment with the > key.

14. Settings / Network

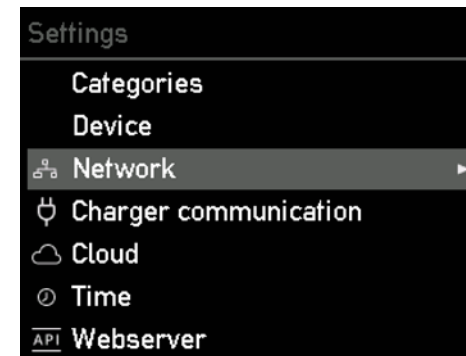

Now you should connect your go-e Controller to your network via WiFi or Ethernet. To select the menu item "Network" in the submenu "Settings" by pressing the > button.

15. Settings / Network / WiFi, Ethernet, Hotspot

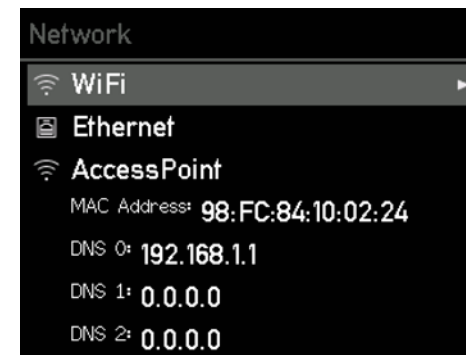

Enter the access data for your WiFi here or configure your Ethernet (LAN) to ensure a connection of the Controller to the network and to go-e Chargers. This is absolutely necessary for PV surplus charging or dynamic load balancing. In addition, you can then connect to the Controller locally without the cloud via the go-e app.

Tip: The WiFi and Ethernet settings can perhaps be made even more conveniently via the go-e app.

10a. Commissioning/operation on the device

16. Settings / Time

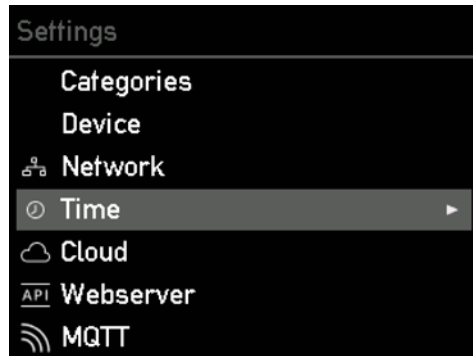

Press the > key to select the menu item "Time".

Advanced users can synchronise the time via an NTP server or the app. If the go-e Controller is connected to the go-e Cloud via the Internet, it always receives the current time from this. In this case, no settings are required here. In the time settings, the time zone can be set and the automatic summer time changeover can be activated.

17. Settings / Cloud

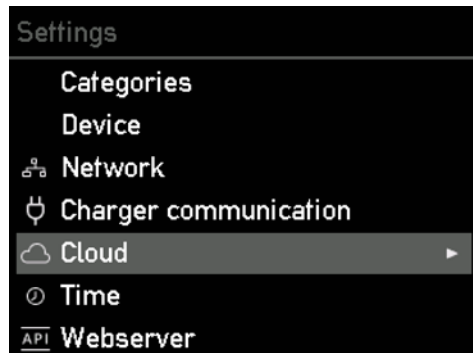

For some functionalities and depending on the go-e Charger you use, a cloud connection may be required. Details can be found in the data sheet of the go-e Controller.

Press the > button to select the "Cloud" menu item.

18. Settings / Cloud

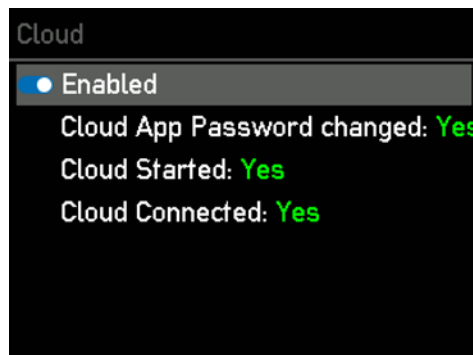

In this submenu you can activate and deactivate the connection to the cloud. The current status is also displayed.

19. Main menu / Chargers

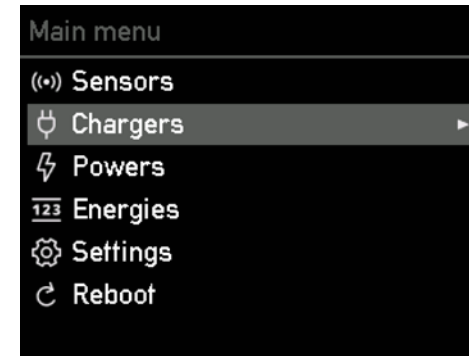

Now it's time to connect your go-e Controller to one or more go-e Chargers.

Press the > key to select the "Chargers" menu item. Then you can theoretically connect an infinite number of go-e Chargers.

20. Chargers / My Chargers



In order to display the go-e Chargers here, the go-e Controller must be in the same network as the go-e Chargers. As mentioned above, you can configure the network in the main menu under Settings. A list of all available Chargers is displayed here. If a Charger is displayed with "Paired", it is already communicating with the Controller. If the Charger says "Found", it is not ready to talk to the Controller. This may be because the automatic search for a Controller is not activated in the settings of the go-e Charger app for the corresponding Charger or the Charger is already connected to another Controller. This is because each Charger can only be connected to exactly one Controller.

10a. Commissioning/operation on the device

21. Chargers / My Chargers / Detail view



In the detailed view of a Charger, you can see more information about its current charging status. You can navigate with the up and down buttons.

Important: The actual settings for the charging process with or without PV surplus or with regard to dynamic load balancing needs to be defined directly for the respective Charger in the go-e app.

22. Settings / Outputs

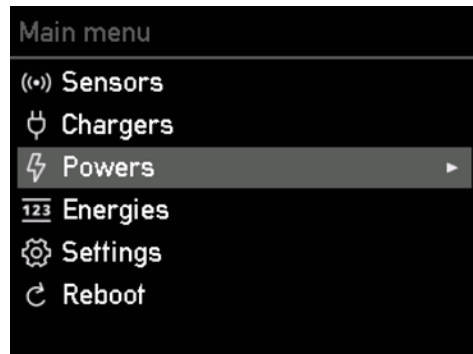

Press the > key to select the "Powers" menu item.

23. Outputs

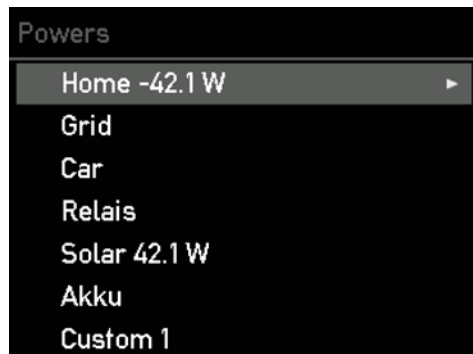

In this submenu you can see the current power of the individual categories.

24. Main menu / Energies

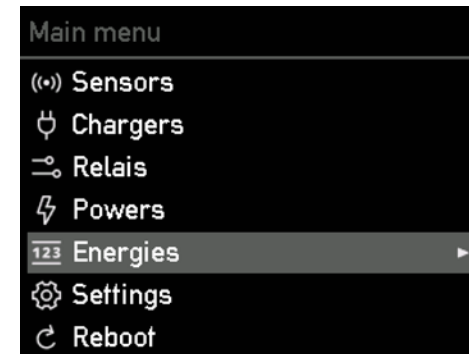

Press the > key to select the "Energies" menu item.

25. Energies



In this submenu you can see for each category its current energy.

26. Settings / Categories



Press the > key to select the menu item "Categories".

10a. Commissioning/operation on the device

27. Categories

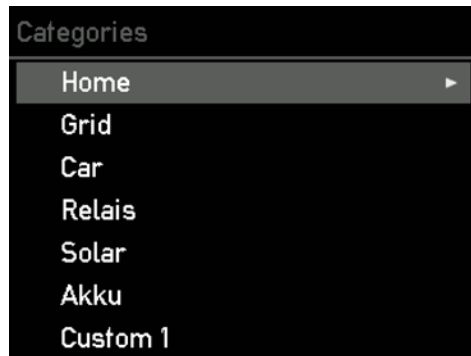

Select the category for which you want to view details and confirm your selection with the > button.

In the following submenu you will get an overview of the performance and energy data of the respective category.

30. Settings / About

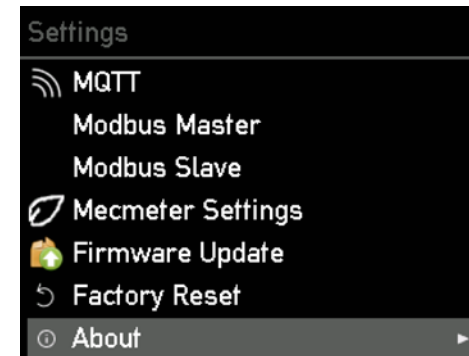

Press the > key to select the "About" menu item. In the submenu you will find all device information about your Controller.

28. Settings / Firmware Update

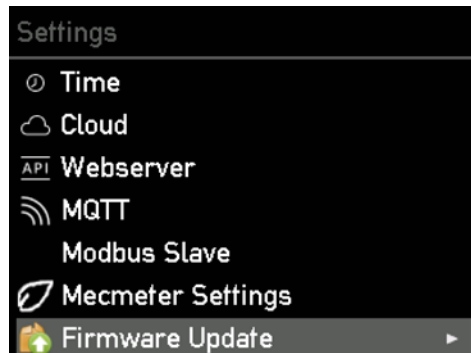

Press the > button to select the menu item "Firmware Update".

In this submenu, download the current firmware for your Controller, if a new version is available for your device. You can also do this in the app.

31. Main menu / Reboot

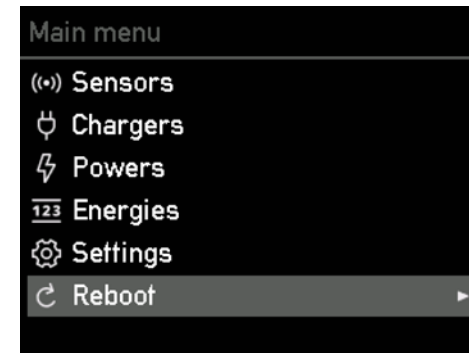

Press the > key to select the menu item "Reboot" in order to reboot the Controller.

29. Settings / Factory Reset



Press the > key to select the "Factory Reset" menu item.

Reset the Controller to factory settings in this submenu if necessary. Either completely or only for a part of the configuration.

32. Settings / Webserver

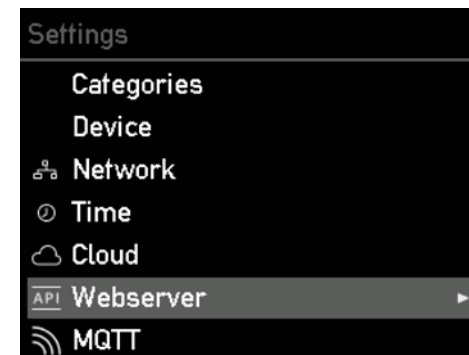

For experts and integrators: Press the > key to select the "Webserver" menu item.

In this submenu you can enable or disable the local HTTP API.

10a. Commissioning/operation on the device

33. Settings / MQTT

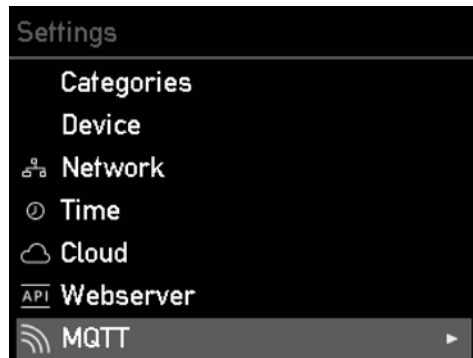

For experts and integrators: Press the > key to select the "MQTT" menu item.

In the submenu you define the settings for the MQTT connection, if you want to use it.

34. Settings / Modbus Slave

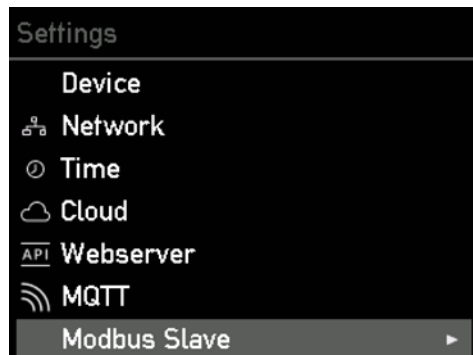

For experts and integrators: Press the > key to select the menu item "Modbus Slave".

In the submenu you can activate Modbus and configure the appropriate settings.

35. Settings / MEC Meter

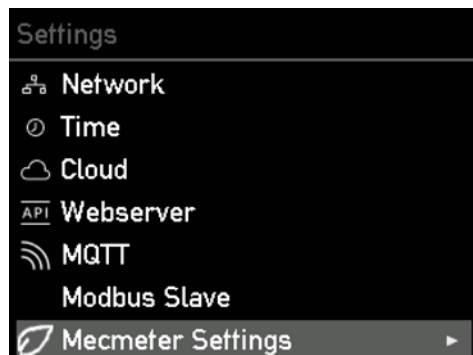

For experts and integrators: Press the > key to select the "MEC Meter" menu item.

This submenu allows you to connect to a MEC meter and set categories for it.

10b. Commissioning/operation via app

Setup in app

You can also perform many of the described configuration steps on the device via the app.

For certain functions, such as controlling excess charging or dynamic load balancing by the individual Chargers, integration of the Controller into the app is mandatory.

If you have already set up a go-e Charger, you have to go back to the device list. If the go-e Controller was already set up, you would see it in the device list. If you haven't set up the Controller yet, press "Add or setup device" to set it up.

a) Use "Setup go-e device" if your Controller has never been set up in a go-e app before.

b) If you have already connected your go-e Controller to the home network directly on the display or with the go-e app, then select "Add go-e device".

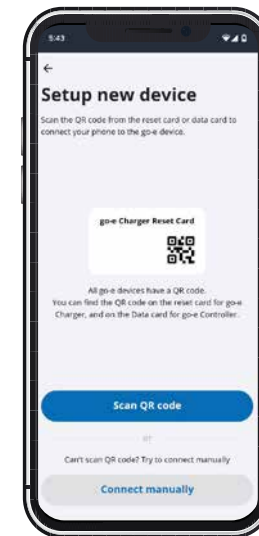
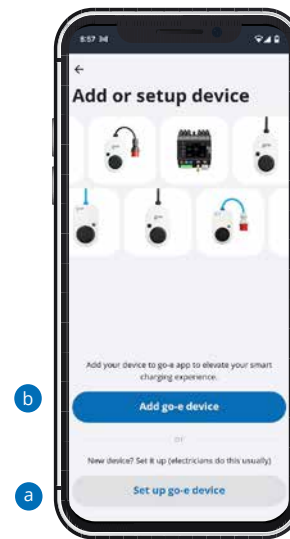

Setup in app

a) "Setup go-e device" is similar to the initial setup of the go-e Charger.

You need to be near the go-e Controller to perform the setup via the hotspot. Note that you might need to disable mobile data and terminate active WiFi connections on some smartphones.

10b. Commissioning/operation via app

To connect to the hotspot automatically, simply scan the QR code on the data card included with the go-e Controller, or connect to the go-e Controller manually in your phone's WiFi settings using the hotspot password provided on the go-e Controller data card. The process is similar to the setup for the go-e Charger.



Setup in app

- b If you want to add an already set up go-e Controller, select "Add go-e device" and enter the serial number of the Controller. You can also find this on the data card enclosed with the Controller. Then type in the password. This is either the default password on the data card or the one you entered during the initial setup, and click "Connect".



Home screen

On the home screen, you can see the current power of each category. The categories solar, grid, home and battery are displayed here by default. Of course, the matching values are only displayed if the setup has been performed for them.

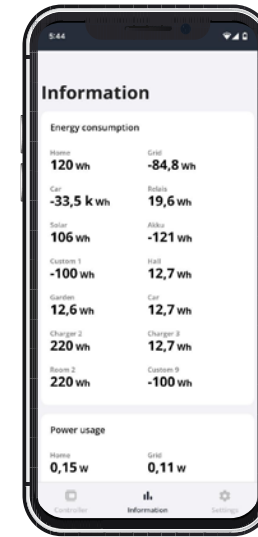

Information

You can find more details about the categories and sensors in the menu item "Information".

Here, for example, all energy flows are shown in a list view.

In the "Information" tab you can see diagrams of your energy flows during the last hours. It is also possible to export all data from the go-e Controller and view it on the PC.

Settings

In the "Settings" menu item of the app, you can configure the sensors, assign them to categories and adjust them via the individual submenu items, just like directly during the configuration on the Controller itself. Time and display settings can also be configured via the app.

Additionally, you can give the Controller an individual name or change the password chosen by you during the initial setup.



Important: If you have made the setup directly via the menu of the Controller, you basically do not need to make any relevant settings for the Controller here in the app. You can jump directly to the end of chapter 10b of this manual.

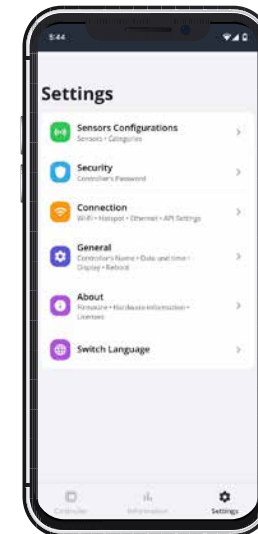

10b. Commissioning/operation via app



Settings / Sensors Configuration / Sensors

As on the Controller itself, you can configure the voltage and current sensors in the menu item "Settings", submenu "Sensors Configuration / Sensors" and read their voltages, currents and powers in real time after selecting them. You can also do this directly on the go-e Controller.

Voltage sensors L1 to L3 always measure the voltage of the connected phases and current sensors Internal 1 to Internal 6 measure the current and power. To ensure that the power calculation by the go-e Controller is really correct and that functionalities such as PV surplus charging and dynamic load balancing work properly, you need to make sure that you have set the correct voltage reference for all phases and that the correct categories and power factors are stored. What exactly has to be observed is explained in this manual in chapter "10a. Commissioning/operation on the device" using various examples. Below, we will only explain where you can find which settings in the app.

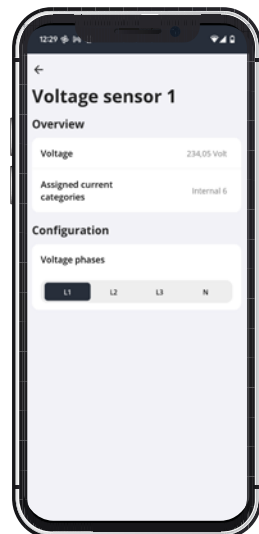

Settings / Sensors Configuration / Sensors / Voltage Sensor

If you select one of the voltage sensors, e.g. voltage sensor L1, you will see all measured values of the selected phase.

If you have connected one or more phases of the power supply incorrectly, you could also change the voltage phase assignments here by pressing "Assigned Phase".

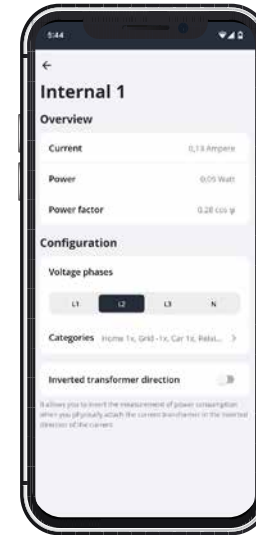

Settings / Sensors Configuration / Sensors / Current Sensor

If you select one of the internals I1 to I6 (loads) in the "Sensors" view, you will get to the data overview of the respective sensor/internal. In the settings directly on the Controller, a similar view can be found under the "Load settings". Here you can invert a load via the slider, if you have not connected a current transformer with the arrows in current direction. Note that the power should always be positive when drawing from the grid. For a solar inverter or AC battery, the power should be positive when feeding. However, if the battery is being charged or the inverter has a higher standby consumption than it generates, the power may be negative. If no power is being consumed, the power should be close to 0.

If you want to adjust an assigned load category or change the phase assignment, this is also possible here in the overview of the respective current sensor. This works similar to the menu of the go-e Controller itself.

10b. Commissioning/operation via app

Settings / Sensors Configuration / Categories

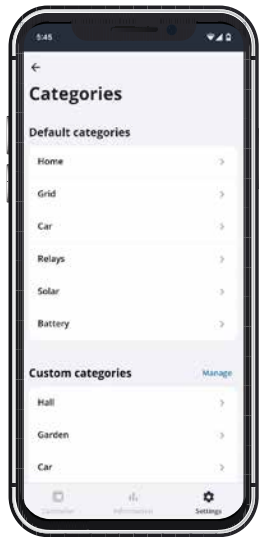

In this submenu you can see an overview of the categories. Select a category and enter a number in the following submenu for the factor with which this current load is to be taken into account.

hold, you should also assign the "Home" category with a factor of 1.

If you measure the current of a three-phase AC PV system with only one sensor on one phase, you must set the factor for the "Solar" category to 3 for the corresponding sensor so that the total power of the PV system can be displayed correctly. This works here because a three-phase inverter delivers the same power on all phases. So you save two sensor connections for other purposes.

For custom categories, you can even change the name of the category, for example, to boiler if you measure it with a sensor.



Settings / Sensors Configuration / Categories / Category details

If you tap on "Categories" in the "Settings" menu, you will get to the sensor configuration view. Here you can select individual categories and then assign the selected category to the various connected sensors. So this is an alternative way to link loads and sensors.

For example, if you measure your mains connection with a sensor, you should assign the factor 1 to this load in the category "Grid". If you do not have a separate sensor on the load branch, in other words the rest of your house-

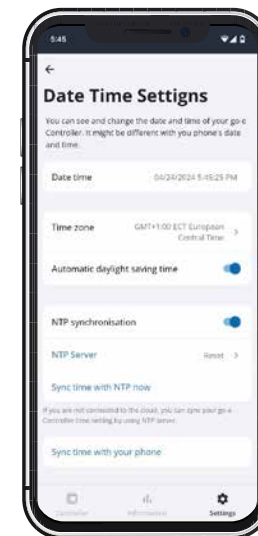

Settings / General / Date Time Settings

Advanced users can synchronize the time via an NTP server or the app. If the go-e Controller is connected to the go-e Cloud via the Internet, it always receives the current time through this. In this case, no settings are required here.

In the time settings, the time zone can be set and the automatic summer time changeover can be activated.

10b. Commissioning/operation via app

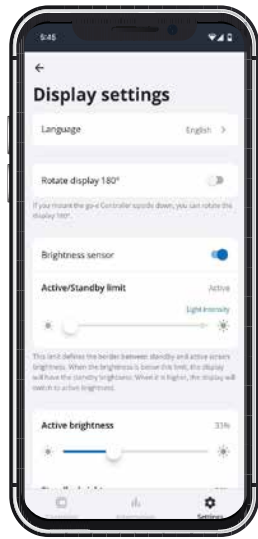

Settings / General / Display settings

In this submenu you can set e.g. the following as on the Controller itself:

1. rotate the display by 180° if you have mounted the Controller upside down due to lack of space
2. select your preferred language
3. adjust the brightness of the display
4. modify the brightness of the display during inactivity
5. define after which period of inactivity the display should go off completely

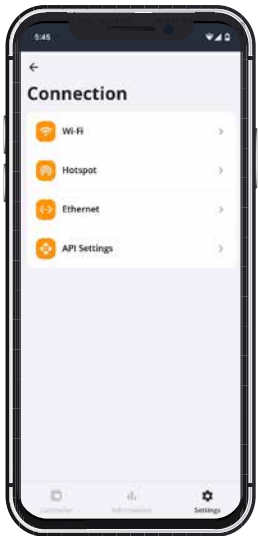

Settings / Connection

All connection settings are made in the "Connection" menu item. In addition to WiFi or Ethernet, additional connections can be defined for experts and integrators.

Settings / About

In the subitem "About you can view information about the hardware. There you will find, for example, the serial number. You can also download the latest firmware.

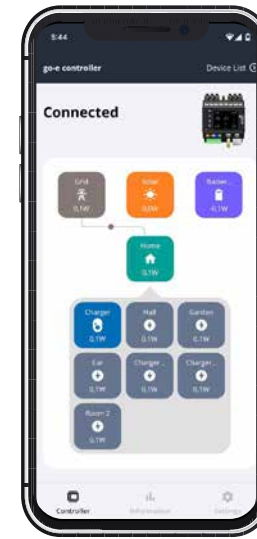

Switching between Controller and Charger

Now let's look at the settings for PV surplus charging and load balancing.

Tap on "Device list" at the top right. There, select the Charger for which you want to make settings for PV surplus charging or load balancing.

11 PV Surplus Charging / Load Balancing

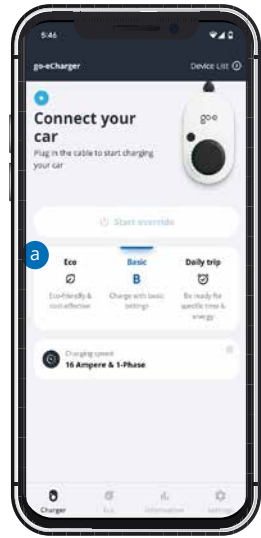

Home screen (go-e Charger)

After switching from your go-e Controller to the go-e Charger, you will be taken to its home screen with the "Charger" view.

- a Remember these mode buttons (Eco, Daily Trip), which you will need to tap later if you want to activate PV surplus charging.

First switch to the "Settings" view.

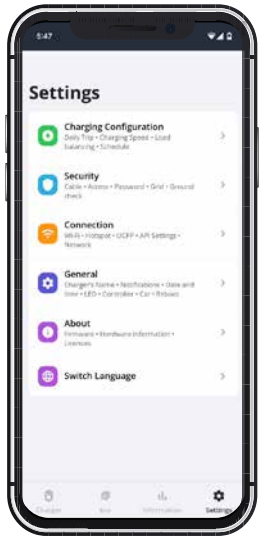

Settings (go-e Charger)

Select the "General / Controller" setting option if your go-e Charger is not yet connected to your Controller. You can also check the connection there.

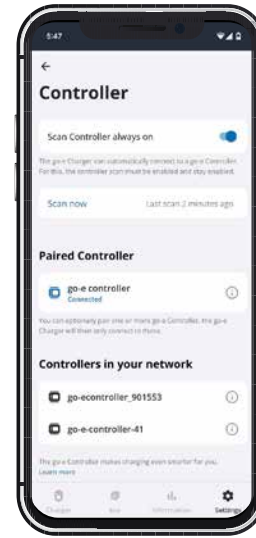

Settings (go-e Charger) / General / Controller

Already installed go-e Controllers can be automatically integrated into the go-e app here. Normally, Controllers are searched for automatically. Only if the Controller has just been installed or you have switched off the automatic scanning function do you have to tap "Scan now" here. By the way, a Charger can only be connected to a single Controller, but the Controller itself can be connected to an unlimited number of Chargers at the same time.

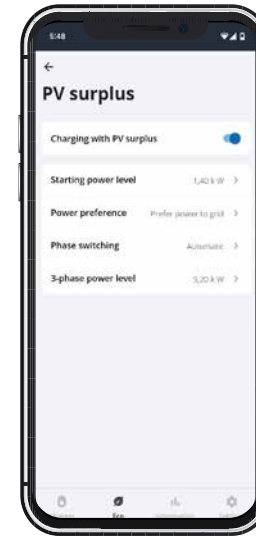

Eco / PV surplus

Once you have ensured that your go-e Charger is connected to the go-e Controller, you can now configure the settings for PV surplus charging. To do this, select the "Eco" tab in the menu bar below and then "PV surplus".

If you have an electricity provider with flexible electricity prices that is listed in the go-e app, you can combine PV surplus charging with the corresponding electricity tariff. However, this is not absolutely necessary for PV surplus charging.

Now activate the "Charging with PV surplus" slider and then adjust the detailed settings for charging with solar power.

11 PV Surplus Charging / Load Balancing

Decide here from which power level of the PV system the charging process should start. If the power is less than 1.4 kW, mains power could also be used. Furthermore, you select whether you would prefer to draw a small amount of electricity from the grid or feed it in during surplus charging - or a mixture of both. This is necessary because you can only charge your EV at certain power levels. You can also specify whether the Charger should adjust the phases with the help of the Controller depending on the power of the PV system and from which power onwards 3-phase charging should be used.

Do you have a DC-coupled battery storage system? Then enter the value -200 in "Grid Target" section to prevent the DC storage system from being permanently discharged when charging the electric vehicle (not possible with HOME series V2). At the same time, the option "Prefer power to grid" must be selected under "Power preference".

You can find more information about these details in our go-e Controller app video on YouTube.

Settings (go-e Charger) / Charging Configuration / Daily Trip

You can also combine PV Surplus charging with the Daily Trip mode. If you want to be sure that the go-e Charger will charge your EV with a certain amount of energy until the morning and you want to use PV electricity or cheap grid electricity from an electricity provider with flexible tariffs, then you should activate the "Daily Trip Mode".

To do this, go to "Settings", then "Charging configuration" and then "Daily Trip". Set the time by which the charging process should be completed at the latest, as well as

the desired amount of electricity or range.

You should also activate the Eco mode options here if you want to reach your charging destination with PV surplus charging and/or flexible electricity tariffs if possible.

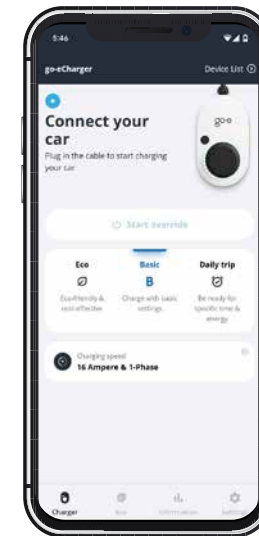
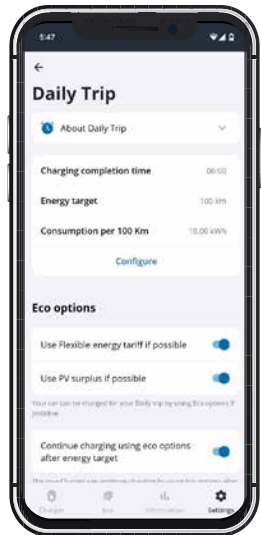

Charger (go-e Charger) / Activate Eco mode or Daily Trip mode

As noted at the beginning of this chapter, you now have to go back to the "Charger" page of your Charger and tap the "Eco" or "Daily Trip" button there, to activate the mode.

After that, your Charger will start charging with PV surplus, provided that your PV system produces electricity that your other consumers in the building do not use.

By the way: You can use both the ECO mode and the Daily Trip mode even without a flexible electricity tariff. In ECO mode, the go-e Charger simply charges when there is surplus PV power available - possibly not at all. In Next Trip mode, the go-e Charger tries to wait as long as possible for surplus power, but then charges power from the grid as late as possible to reach your desired amount of energy.

11. PV Surplus Charging / Load Balancing

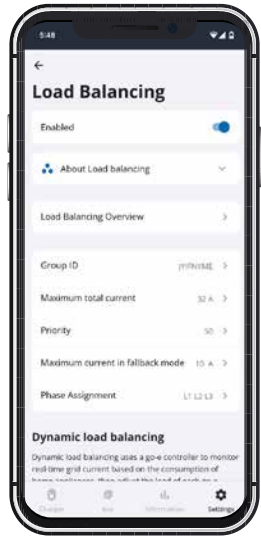

Settings (go-e Charger) / Charging Configuration / Load balancing

If you want to use dynamic load balancing, tap at the bottom of the app on "Settings", then "Charging configuration" and afterwards "Load balancing".

With your go-e Controller, you can combine static and dynamic load balancing.

You store the value for dynamic load balancing in the "Maximum grid current" line. This is the maximum current in amperes that your house can draw from the grid.

The go-e Controller will ensure that this value is never exceeded when charging your electric car in combination with the power demand of your other consumers. If necessary, the go-e Controller regulates the charging power down and later up again.

12. Manufacturer's guarantee and exclusions

1. go-e GmbH grants a manufacturer's guarantee for go-e Controllers against material and functional defects in accordance with the following conditions. The guarantee period is 24 months from receipt of the goods after the first purchase of the product from go-e or a reseller. This guarantee is in addition to the statutory warranty and does not limit it.

2. The guarantee is only valid on presentation of proof of purchase stating the date of purchase.

3. In the event of a guarantee claim, the customer has to inform go-e GmbH immediately in text form to complain about the defect. In the event of a justified notice of defect, go-e is obliged to improve or replace the goods as soon as possible or to arrange this. In the (justified) case of the return of the defective product to go-e, go-e will bear the costs incurred. If, in the event of a guarantee claim, it becomes apparent that the device needs to be replaced, the customer waives ownership of the previous device from the date of return shipment and the new device simultaneously becomes the property of the buyer. This transfer of ownership also applies if, as a gesture of goodwill, a device is replaced outside the guarantee period at reduced conditions. In any case, evidence in the form of an invoice has to be provided. For safety reasons, the disassembly of an allegedly defective, permanently installed go-e product may only be carried out by a qualified electrician. Before dismantling the product, always contact go-e's technical customer support and wait for its decision on the further procedure for handling the service case. Repairs may only be carried out by the manufacturer go-e. For repairs not carried out by go-e, there shall be no claim to reimbursement of costs under the guarantee.

4. In the event of incorrect storage, use or installation/mounting by the buyer/installer and resulting damage to the product or other technical defects caused by the buyer/installer, the guarantee and statutory warranty shall expire. In this case the buyer bears the shipping costs. This applies especially if the product is used for other purposes than those specified by the manufacturer.

5. The guarantee and warranty also expires in the event of any modification or opening of a go-e product or if there is no proof of installation by a qualified professional. (e.g. commissioning certificate)

6. go-e GmbH shall make every reasonable effort to provide the operation of all free digital supplementary services in accordance with the representations in the operating instructions of the products, including but not limited to app and cloud functions. go-e does not, however, guarantee that these will always function error-free, fully available and without interruption. go-e GmbH does not provide any guarantee, warranty or assurance for these digital additional functions, but will endeavor to provide a workaround or update to rectify errors or eliminate faults free of charge within a reasonable period of time following an error/fault report by the customer. The customer's report can be made by telephone during go-e business hours, by e-mail to office@go-e.com or by using the contact form on the go-e website. go-e shall be entitled to apply restrictions for the elimination of errors/malfunctions and/or workarounds, as well as to postpone the elimination of errors/malfunctions until the release of an update. In order to fulfil this obligation, go-e GmbH is entitled to suspend the digital supplementary services due to planned or unplanned maintenance work, which is why go-e does not guarantee that the digital services will be available without restriction at any given time.

7. Claims arising from this guarantee shall be governed exclusively by Austrian law, excluding the conflict of laws provisions, in particular the UN Convention on Contracts for the International Sale of Goods.

13. CE Declaration of Conformity



Hereby go-e GmbH declares that the radio equipment type go-e Controller is in compliance with Directive 2014/53/EU. The full text of the EU Declaration of Conformity is available at the following internet address: www.go-e.com





Support

go-e GmbH

Satellitenstraße 1
9560 Feldkirchen
AUSTRIA

✉ support@go-e.com

☎ +43 4276 62400

www.go-e.com

Online support

www.go-e.com



go-e